

TYPICAL APPLICATION CIRCUIT [47000 SERIES]

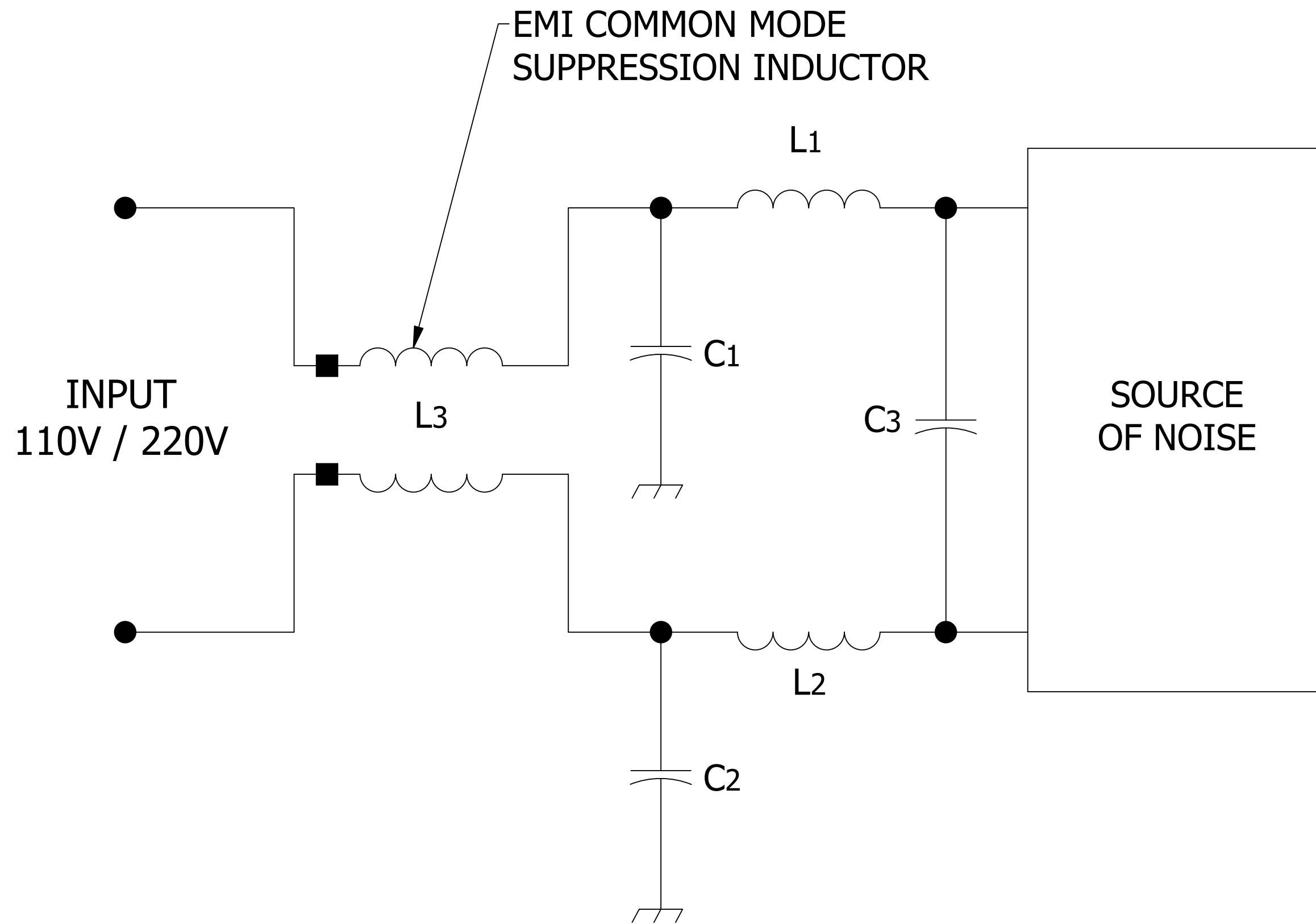

A TYPICAL CIRCUIT FOR THE ELIMINATION OF NOISE IS SHOWN ABOVE. THE FILTER CONTAINS TWO STAGES; ONE FOR COMMON MODE NOISE [L3, C1, C2] AND ONE FOR CONDUCTED NOISE [L1, L2, C3]

DRAWN	P.PALUCH	PICO Electronics	143 Sparks Ave Village of Pelham, NY 10803	
CHECKED	H. VIDAURRE			
QA		47000 SERIES		
MFG				
APPROVED		SIZE	DWG NO	REV
REVISION DATE	06/06/2023	C		1
		SCALE	NTS	www.picoelectronics.com

TERMINAL ARRANGEMENT [47000 SERIES]

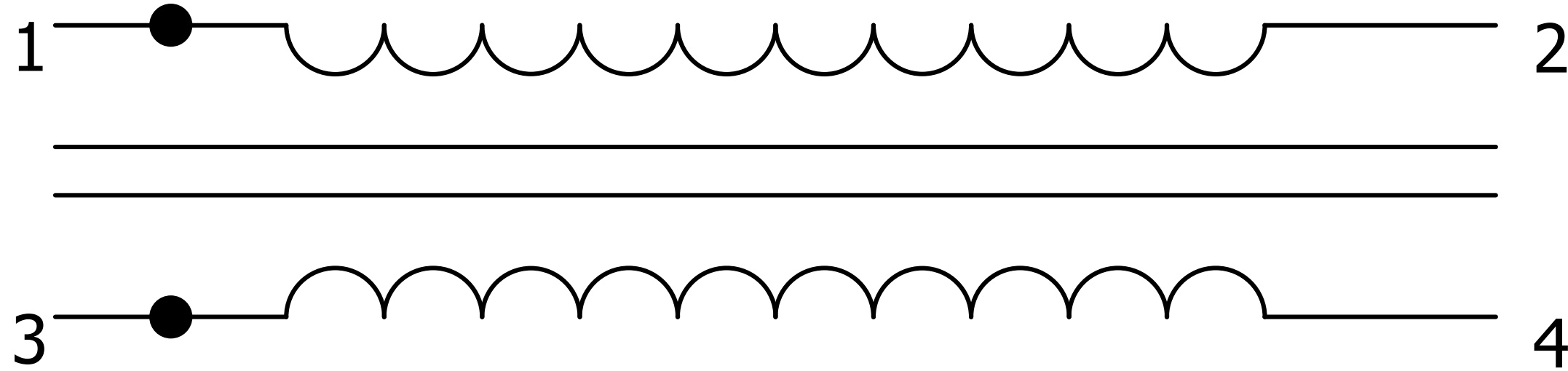

DRAWN	P.PALUCH	PICO	143 Sparks Ave	
CHECKED	H. VIDAURRE		Village of Pelham, NY 10803	
QA		Electronics		
MFG		47000 SERIES		
APPROVED		SIZE	DWG NO	REV
REVISION DATE	06/06/2023	C		1
		SCALE	NTS	www.picoelectronics.com