

NOTES

- a. ALL DIMENSIONS ARE IN INCHES, [] = MM
- b. TERMINALS ARE CLOCKWISE FROM PIN #1

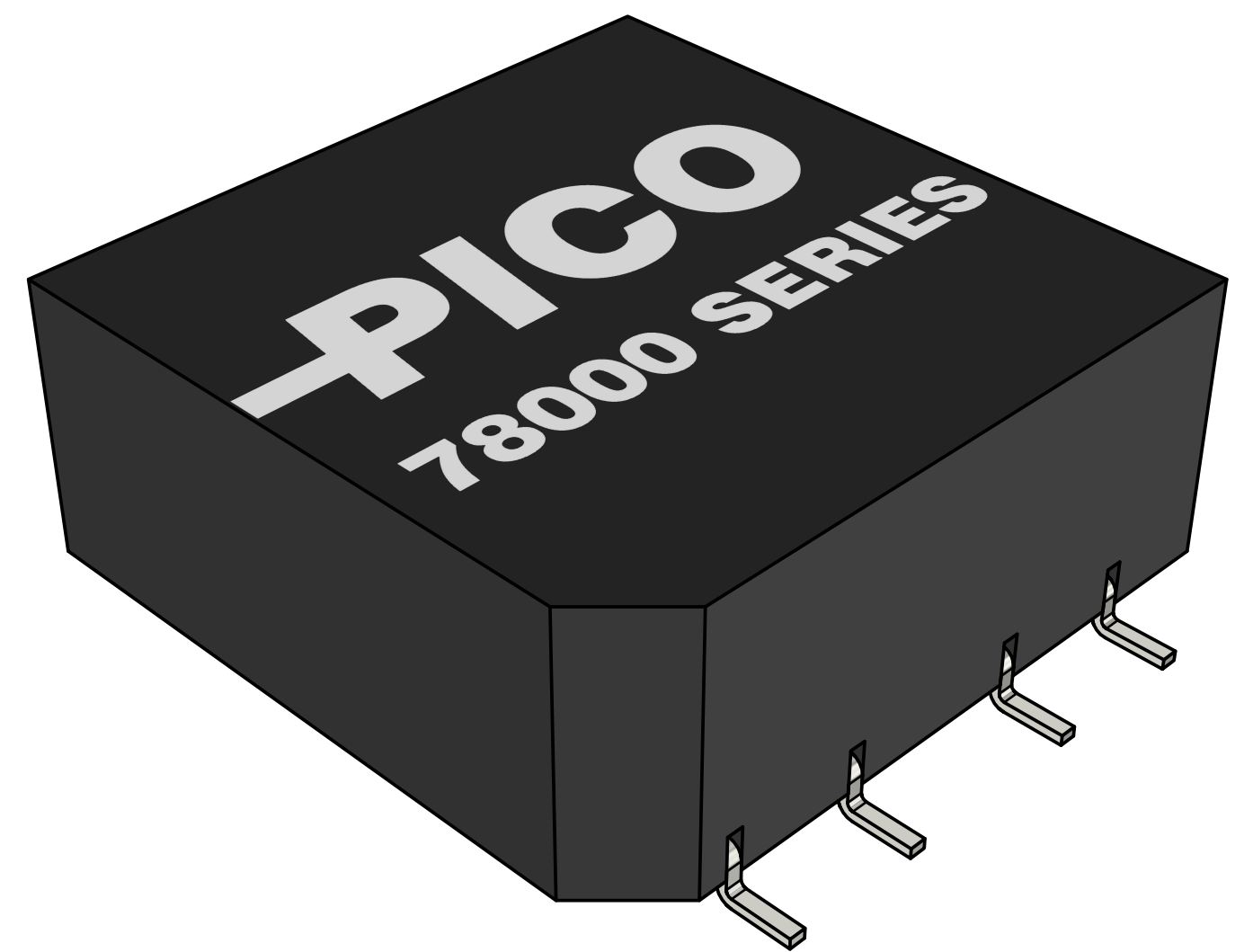
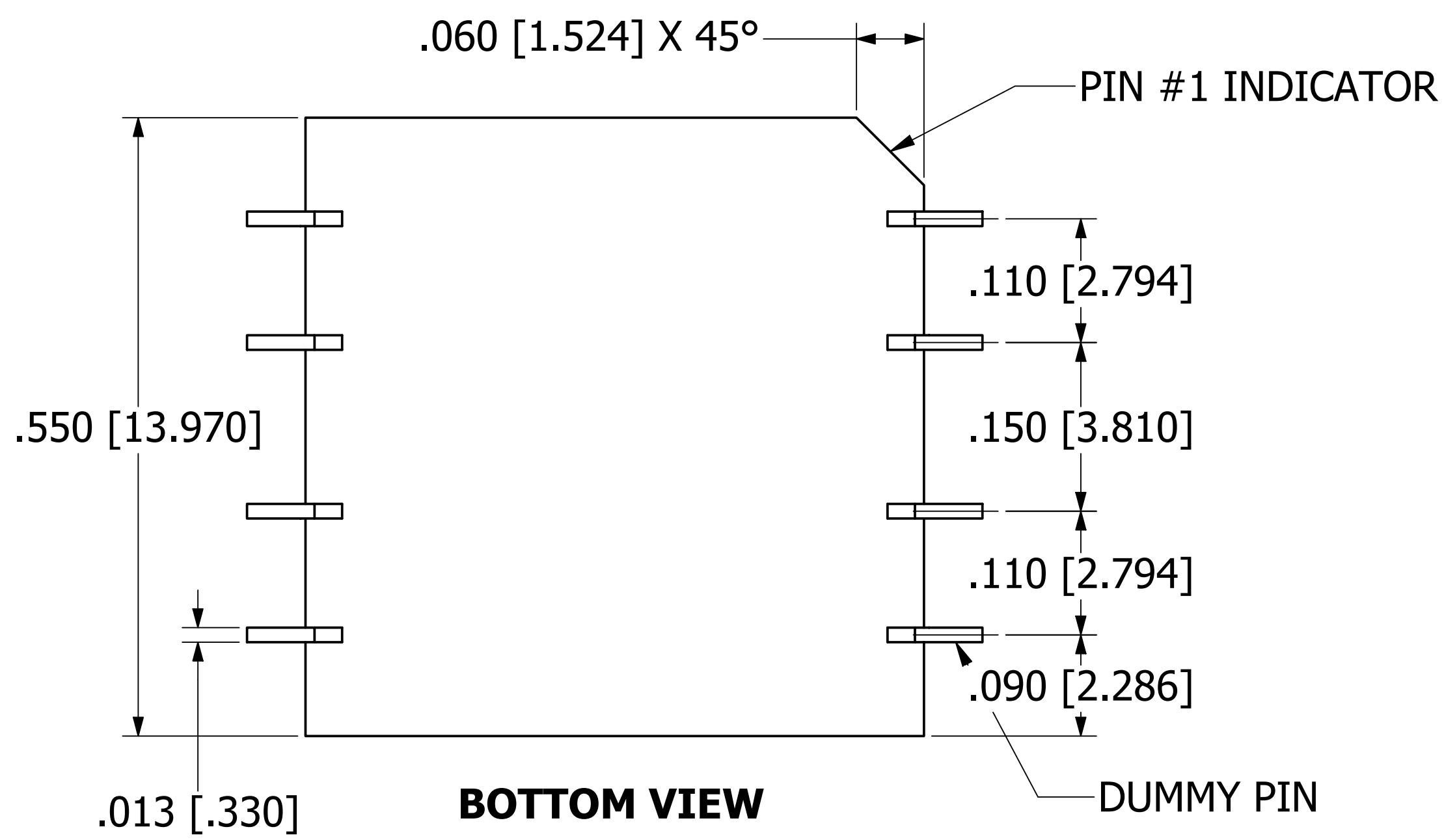
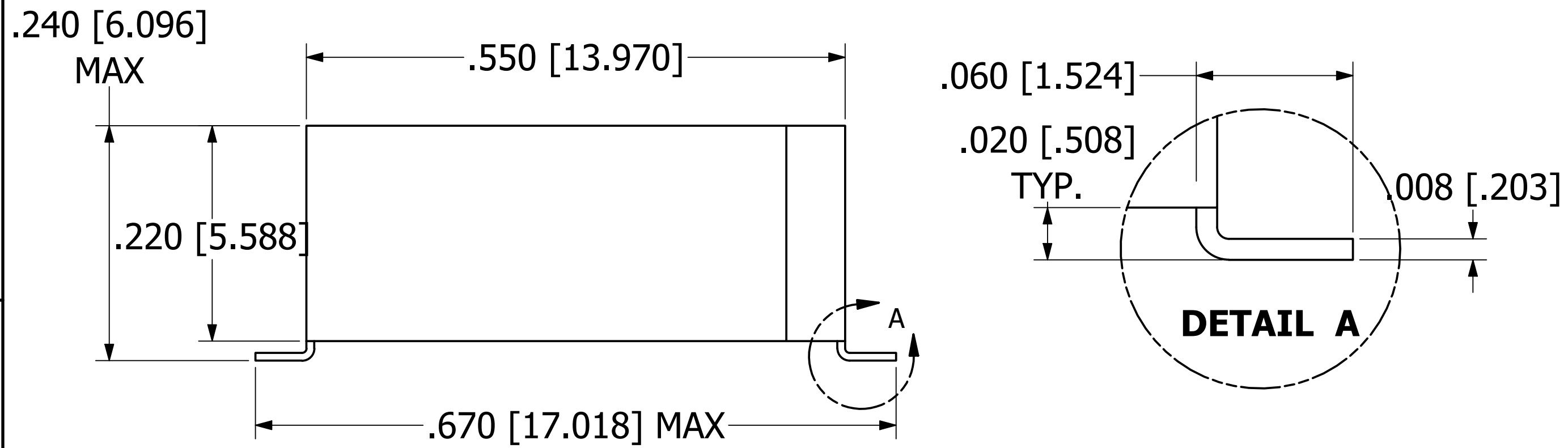

BOTTOM VIEW

PROPRIETARY AND CONFIDENTIAL
 THE INFORMATION CONTAINED IN THIS DRAWING IS THE SOLE PROPERTY OF
 PICO ELECTRONICS INC. ANY REPRODUCTION IN PART OR AS A WHOLE WITHOUT THE WRITTEN
 PERMISSION OF PICO ELECTRONICS INC. IS PROHIBITED

DRAWN	P.PALUCH	PICO Electronics	143 Sparks Ave Village of Pelham, NY 10803	
CHECKED	H. VIDAURRE			
QA		78000 SERIES		
MFG				
APPROVED		SIZE	DWG NO	REV
REVISION DATE	06/06/2023	C		1
		SCALE	NTS	www.picoelectronics.com